



EL CATALOGO





EL CATALOGO DE
MANTENIMIENTO
Y REPARACIÓN PARA
LOS PROFESIONALES

46







**PIES DE REY, CALIBRES,
GRAMILES Y GOBERNANTES**

- p. 554  Pie de rey digitales
- p. 555  Medidores con cuadrante
- p. 555  Pie de rey
- p. 559  Gramiles
- p. 559  Reglas digitales

COMPARADORES

- p. 560  Comparadores analógico
- p. 562  Medidor de espesores
- p. 563  Centrado

MICRÓMETROS

- p. 564  Micrometro de exteriores
- p. 565  Micrometro de interiores

**BLOQUES PATRÓN, CALAS, ANILLOS
Y TAMPONES DE CONTROL**

- p. 566  Calas sueltas de acero
- p. 567  Anillo de control

**ACCESORIOS
PARA MEDIR**

- p. 569  Bases magnéticas
- p. 572  Marmol de control
- p. 572  Escuadra
- p. 574  Galga de roscas

**FLEXOMETROS, NIVELES
Y GONIOMETROS**

- p. 577  Flexometro
- p. 578  Nivel
- p. 580  Goniometros

**MEDIDORES ANALÓGICOS
Y DIGITALES**

- p. 581  Endoscopio
- p. 582  Tester
- p. 583  Medidores digitales
- p. 587  Refractometro
- p. 588  Durometri

**BÁSCULAS Y
DINAMÓMETROS**

- p. 590  Básculas
- p. 591  Dinamómetros

C031/150
€ 193,00
PIE DE REY ELECTRONICO DIGITAL DE ACERO INOX

Con 2 funciones y una pantalla grande.



Útil	0÷150 mm 0÷6"
Lectura	0,01 mm 0,0005"
Bocas	40 mm
Barra	16 x 3 mm
Batería	1 x LR44

C035-
PIE DE REY ELECTRÓNICO DIGITAL DE ACERO INOX

Con riel de vidrio para mayor precisión, carcasa y botones de metal, salida de datos con puerto mini USB, thumbroll extraíble, mordazas rectificadas y lapeadas, con tornillo de bloqueo.



Art.	€	Útil	Lectura	Precisión	Ripetibilità	Barra	Bocas	Bocas para interior	Batería	Altura de dígitos
C035/150	€ 75,90	0÷150 mm 0÷6"	0,01 mm 0,0005"	0,02 mm	0,01 mm	16 x 3 mm	40 mm	16,5 mm	1 x 3V CR2032	9 mm
C035/200	€ 104,00	0÷200 mm 0÷8"	0,01 mm 0,0005"	0,03 mm	0,01 mm	16 x 3 mm	50 mm	19,5 mm	1 x 3V CR2032	9 mm
C035/300	€ 182,00	0÷300 mm 0÷12"	0,01 mm 0,0005"	0,03 mm	0,01 mm	16 x 3 mm	60 mm	20,5 mm	1 x 3V CR2032	9 mm

C033-
PIE DE REY ELECTRÓNICO DIGITAL DE ACERO INOX

Con 3 funciones con pantalla grande.

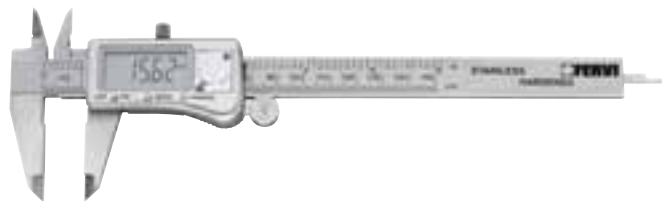

Art.	€	Útil	Lectura	Barra	Bocas	Batería
C033/150	€ 66,90	0÷150 mm 0÷6"	0,01 mm 0,0005"	16 x 3,2 mm	40 mm	1 x LR44
C033/200	€ 97,40	0÷200 mm 0÷8"	0,01 mm 0,0005"	16 x 3,2 mm	50 mm	1 x LR44
C033/300	€ 145,00	0÷300 mm 0÷12"	0,01 mm 0,0005"	16 x 3,2 mm	60 mm	1 x LR44

C041/150
€ 37,50
PIE DE REY ELECTRÓNICO MONOBLOQUE DIGITAL DE ACERO INOX

Con tres funciones y pantalla grande.



Útil	0÷150 mm 0÷6"
Lectura	0,01 mm 0,0005"
Bocas	40 mm
Barra	16 x 3 mm
Batería	1 x LR44



**C043-****PIE DE REY ELECTRONICO DIGITAL DE ACERO INOX**

4 funciones con gran pantalla, tornillo de ajuste fino.



Art.	€	Útil	Lectura	Bocas	Barra	Batería
C043/500	€ 357,00	0÷500 mm 0÷20"	0,01 mm 0,0005"	100 mm	25 x 6 mm	1 x LR44
C043/1000	€ 713,00	0÷1000 mm 0÷40"	0,01 mm 0,0005"	150 mm	30 x 8 mm	1 x LR44

C005/150**€ 58,90****PIE DE REY CON RELOJ COMPARADOR DE ACERO INOX**

Útil	0 ÷ 150 mm
Lectura	0,01 mm
Bocas	40 mm
Barra	15,5 x 3 mm

C006-**PIE DE REY CON RELOJ COMPARADOR DE ACERO INOX**

Art.	€	Útil	Lectura	Bocas	Barra
C006/150	€ 52,80	0 ÷ 150 mm	0,02 mm	40 mm	16 x 3 mm
C006/200	€ 80,40	0 ÷ 200 mm	0,02 mm	50 mm	16 x 3 mm
C006/300	€ 131,00	0 ÷ 300 mm	0,02 mm	60 mm	20 x 4 mm

C018-**PIE DE REY MONOBLOQUE DE ACERO INOX CROMADO OPACO**

Art.	€	Útil	Lectura	Bocas	Barra
C018/150	€ 39,70	0÷150 mm 0÷6"	1/20 0,05 mm 1/128"	40 mm	16 x 3 mm
C018/200	€ 61,80	0÷200 mm 0÷8"	1/50 0,02 mm 1/1000"	50 mm	16 x 3 mm

C057/150
€ 22,80
PIE DE REY SATINADO

Útil	0÷150 mm 0÷6"
Lectura	1/20 0,05 mm 1/128"
Bocas	40 mm
Barra	16 x 3 mm

C011-
PIE DE REY MONOBLOQUE DE ACERO INOX CROMADO OPACO

Gran precisión, con rueda para bloqueo del cursor, rango de medición 0 – 200 mm.



Art.	€	Útil	Lectura	Bocas	Barra
C011/150	€ 43,30	0÷150 mm 0÷6"	1/50 0,02 mm 1/1000"	40 mm	16 x 3 mm
C011/200	€ 71,80	0÷200 mm 0÷8"	1/50 0,02 mm 1/1000"	50 mm	16 x 3 mm

C019/150
€ 18,10
PIE DE REY SATINADO

Útil	0÷150 mm 0÷6"
Lectura	1/20 0,05 mm 1/128"
Bocas	40 mm
Barra	16 x 3 mm

C056/200
€ 31,70
PIE DE REY SATINADO

Útil	0÷200 mm 0÷8"
Lectura	1/50 0,02 mm 1/1000"
Bocas	50 mm
Barra	16,5 x 3,5 mm



**C049/300**

€ 66,90

PIE DE REY SATINADO

Tornillo de ajuste fino.



Caja



862

Útil	0 ÷ 300 mm
Lectura	1/50 - 0,02 mm
Bocas	60 mm
Barra	20 x 4 mm

**C021-****PIE DE REY MONOBLOQUE SATINADO INOX**

Tornillo de ajuste fino.



Caja



862

Art.	€	Útil	Lectura	Bocas	Barra
C021/300	€ 188,00	0÷300 mm 0÷12"	1/50 0,02 mm 1/1000"	100 mm	23 x 6 mm
C021/500	€ 258,00	0÷500 mm 0÷20"	1/50 0,02 mm 1/1000"	150 mm	23 x 6 mm
C021/1000	€ 576,00	0÷1000 mm 0÷40"	1/50 0,02 mm 1/1000"	150 mm	32 x 8 mm

**C020-****PIE DE REY SATINADO**

Tornillo de ajuste fino.



Caja



862

Art.	€	Útil	Lectura	Bocas	Barra
C020/500	€ 162,00	0 ÷ 500 mm	1/50 0,02 mm	100 mm	23 x 6 mm
C020/1000	€ 401,00	0 ÷ 1000 mm	1/50 0,02 mm	150 mm	30 x 8 mm
C020/1500	€ 1120,00	0 ÷ 1500 mm	1/50 0,02 mm	225 mm	49 x 14 mm
C020/2000	€ 1810,00	0 ÷ 2000 mm	1/50 0,02 mm	250 mm	50 x 15 mm

**C044-****PIE DE REY ELECTRONICO DIGITAL DE PROFUNDIDAD DE ACERO INOX**

De 3 funciones con gran pantalla.



Caja



862

Art.	€	Útil	Lectura	Base	Barra	Peso de la batería (Kg)	Batería
C044/200	€ 94,50	0÷200 mm 0÷8"	0,01 mm 0,0005"	100 mm	13 x 3,5 mm	0,002	1 x LR44
C044/300	€ 162,00	0÷300 mm 0÷12"	0,01 mm 0,0005"	150 mm	15 x 4 mm	0,002	1 x LR44





C007-

PIE DE REY DE PROFUNDIDAD SATINADO



Art.	€	Útil	Lectura	Base	Barra
C007/200	€ 40,90	0 ÷ 200 mm	1/50 0,02 mm	100 mm	9,6 x 4,5 mm
C007/300	€ 56,20	0 ÷ 300 mm	1/50 0,02 mm	100 mm	12 x 4 mm

C010/200

PIE DE REY MONOBLOQUE SATINADO PARA TRAZAR

€ 59,10

C010/200P € 8,70
SET DE PUNTAS



Útil	0÷200 mm 0÷8"
Lectura	1/10 0,1 mm 1/64"
Bocas	10 mm
Barra	16 x 3 mm



CF08

CALIBRE PARA MEDIR LA DISTANCIA AL CENTRO DE LOS AGUJEROS DE LA TUERCA DE LA RUEDA

Para las mediciones de los agujeros de las llantas en acero y aluminio. Facilita la medición del diámetro de los agujeros. Apto para llantas de 4, 5, 6 y 8 agujeros

€ 9,20



Útil	4-8 LUG 100 ÷ 210 mm
------	----------------------



**T092-****GRAMIL DE ALTURAS DIGITAL MULTIFUNCIÓN**

De 4 funciones con gran pantalla, con punta para trazar.

UPGRADE

Caja

Art.	€	Campo de medición	Lectura	Precisión	Peso neto	Batería
T092/300	€ 595,00	0÷300 mm 0÷12"	0,01 mm 0,0005"	0,03 mm 0,015"	4 kg	1x 3V CR2032
T092/600	€ 989,00	0÷600 mm 0÷24"	0,01 mm 0,0005"	0,05 mm 0,025"	9 kg	1x 3V CR2032

**T100-****GRAMIL DE ALTURAS DE ACERO CROMADO OPACO**

Con punta para trazar.



Caja

Art.	€	Campo de medición	Lectura	Peso neto
T100/300	€ 121,00	0 ÷ 300 mm	0,02 mm	2 kg
T100/500	€ 239,00	0 ÷ 500 mm	0,02 mm	5,5 kg

**Rx****LINEA CON DISPLAY DIGITAL MULTIFUNCIÓN**

La regla puede ser cortada para ser utilizada a la longitud deseada, con sus funciones: on/off - mm/inch - zero - abs/inc - interruptor automático.



Caja

Art.	€	Longitud total	Útil	Lectura	Batería
R060	€ 90,00	630 mm - 24.8" inch	500 mm - 19.7"	0,01 mm 0.001"	2 x 3 V CR2032
R100	€ 117,00	1000 mm - 40" inch	900 mm - 35"	0,01 mm 0.001"	2 x 3 V CR2032

C064 € 115,00
RELOJ COMPARADOR DIGITAL CENTESIMAL MULTIFUNCIÓN

Funciones principales: reiniciar en cualquier posición, conversión mm/inch, búsqueda y memoria y min/max, apagado automático.



Caja 878

Campo de medición	0÷12,7 mm 0÷0,5"
Resolución	0,01 mm 0,005"
Precisión	0,02 mm 0,002"
Diámetro esfera	60 mm
Batería	1x SR44W

C004 € 94,90
RELOJ COMPARADOR MILESIMAL

Caja 878

Diámetro esfera	60 mm
Campo de medición	0 ÷ 1 mm
Lectura	0,001 mm
Precisión	0,002 mm

C002 € 57,10
RELOJ COMPARADOR CENTESIMAL

Caja 878

Diámetro esfera	60 mm
Campo de medición	10 mm
Lectura	0,01 mm
Precisión	0,015 mm

C023G € 22,10
RELOJ COMPARADOR CENTESIMAL

Caja 878

Diámetro esfera	60 mm
Campo de medición	10 mm
Lectura	0,01 mm
Precisión	0,015 mm

C060 € 241,00
RELOJ COMPARADOR DIGITAL MILESIMAL MULTIFUNCIÓN

Funciones principales: reiniciar en cualquier posición, conversión mm/inch, búsqueda y memoria y min max, apagado automático.



Caja 878

Útil	0÷2,40 mm 0÷0,094"
Lectura	0,01 mm 0,0005"
Dimensiones plato	Ø 24 mm
Altura de dígitos	8 mm
Batería	1 x 3V CR2032
Dimensiones	Ø 50 x 51 mm

C017 € 65,70
RELOJ COMPARADOR CENTESIMAL

Con movimiento sobre rubí's antichoque y resistente a rociadas de agua.



Caja 878

Diámetro esfera	55 mm
Campo de medición	10 mm
Lectura	0,01 mm
Precisión	0,015 mm

C023 € 33,50
RELOJ COMPARADOR CENTESIMAL

Caja 878

Diámetro esfera	60 mm
Campo de medición	10 mm
Lectura	0,01 mm
Precisión	0,015 mm

C023/N € 37,90
RELOJ COMPARADOR CENTESIMAL

Caja 878

Diámetro esfera	60 mm
Campo de medición	10 mm
Lectura	0,01 mm
Precisión	0,015 mm



**C002/42****€ 41,20****RELOJ COMPARADOR CENTESIMAL**

Caja

878



Diámetro esfera	42 mm
Campo de medición	5 mm
Lectura	0,01 mm
Precisión	0,015 mm

C048**€ 80,50****RELOJ COMPARADOR CENTESIMAL**

Con orejeta trasera.



Caja

878



Diámetro esfera	60 mm
Campo de medición	30 mm
Lectura	0,01 mm
Precisión	0,015 mm

T003-**RELOJ COMPARADOR CENTESIMAL CON PALPADOR**

Caja

2270



Art.	€	Diámetro esfera	Campo de medición	Lectura	Precisión	Broca palpadora
T003	€ 101,00	32 mm	0,8 mm	0,01 mm	0,015 mm	Ø 2 mm
T003G	€ 60,10	32 mm	0,8 mm	0,01 mm	0,008 mm	Ø 2 mm

T007-**RELOJ COMPARADOR CENTESIMAL CON PALPADOR**

Caja



Art.	€	Diámetro esfera	Campo de medición	Lectura	Precisión	Broca palpadora
T007	€ 102,00	40 mm	0,8 mm	0,01 mm	0,011 mm	Ø 2 mm
T007G	€ 65,20	40 mm	0,8 mm	0,01 mm	0,008 mm	Ø 2 mm

T006**€ 109,00****RELOJ COMPARADOR CENTESIMAL CON PALPADOR LARGO**

Caja

2270



Diámetro esfera	40 mm
Campo de medición	0,8 mm
Lectura	0,01 mm
Precisión	0,011 mm
Broca palpadora	Ø 2 mm
Longitud punta palpadora	29 mm

T005**€ 121,00****RELOJ COMPARADOR BIMILESIMAL CON PALPADOR**

Caja

2270



Diámetro esfera	32 mm
Campo de medición	0,2 mm
Lectura	0,002 mm
Precisión	0,005 mm
Broca palpadora	Ø 2 mm

T011**€ 92,60****RELOJ COMPARADOR CENTESIMAL CON PALPADOR**

Caja

2270



Diámetro esfera	32 mm
Campo de medición	0,8 mm
Lectura	0,01 mm
Precisión	0,011 mm
Broca palpadora	Ø 2 mm

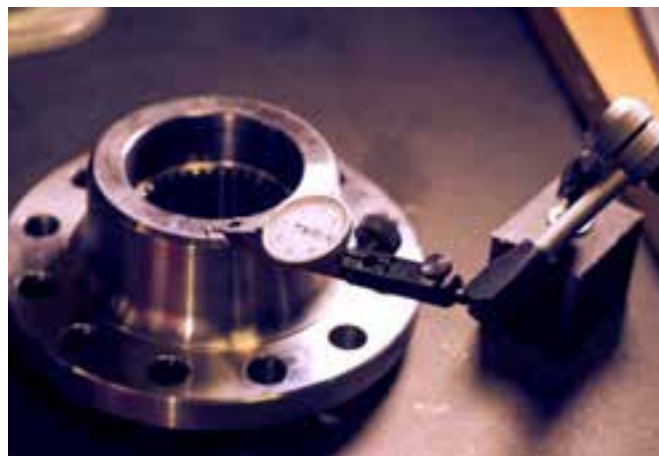

A016-
ALEXOMETRO CON RELOJ COMPARADOR



Caja

Art.	€	Campo de medición	Lectura	Profundidad orificio
A016/6/10	€ 156,00	6 ÷ 10 mm	0,01 mm	40 mm
A016/10/18	€ 161,00	10 ÷ 18 mm	0,01 mm	100 mm
A016/18/35	€ 161,00	18 ÷ 35 mm	0,01 mm	125 mm
A016/35/50	€ 161,00	35 ÷ 50 mm	0,01 mm	150 mm
A016/50/160	€ 161,00	50 ÷ 160 mm	0,01 mm	150 mm
A016/160/250	€ 180,00	160 ÷ 250 mm	0,01 mm	400 mm
A016/250/450	€ 204,00	250 ÷ 450 mm	0,01 mm	400 mm

M055/120 € 105,00
MEDIDOR DE ESPESORES



Caja

Campo de medición	0 ÷ 10 mm
Lectura	0,01 mm
Profundidad de medición	120 mm

C016 € 172,00
MEDIDOR DE PROFUNDIDAD



Caja

Campo de medición	0 ÷ 110 mm
Recorrido comparador	0 ÷ 10 mm
Dimensiones base	63 x 17 mm
Lectura	0,01 mm
Alargaderas	10 pz

M062 € 26,10
MEDIDOR DIGITAL DE ESPESORES



Caja

Campo de medición	0 ÷ 12 mm - 0 ÷ 0,5"
Lectura	0,01 mm 0,0005"
Profundidad de medición	20 mm
Precisión	±0,1 mm 0,004"
Batería	1 x LR44

M055 € 69,10
MEDIDOR DE ESPESORES



Caja

Campo de medición	0 ÷ 10 mm
Lectura	0,01 mm
Profundidad de medición	9 ÷ 16 mm

C014-
CALIBRADOR RAPIDO DE INTERIORES



Caja

Art.	€	Campo de medición	Brazos	Palpadores	Lectura
C014/15/35	€ 156,00	15 ÷ 35 mm	50 mm	Ø 3 x 3 mm	0,01 mm
C014/35/55	€ 156,00	35 ÷ 55 mm	80 mm	Ø 3 x 6 mm	0,01 mm
C014/55/75	€ 156,00	55 ÷ 75 mm	80 mm	Ø 3 x 6 mm	0,01 mm
C014/75/95	€ 156,00	75 ÷ 95 mm	100 mm	Ø 3 x 8 mm	0,01 mm

A020 € 147,00
PALPADOR CON RELOJ COMPARADOR Y BASE MAGNETICA



Caja

Altura de puesta a cero	50 mm
Lectura	0,01 mm
Útil	0 ÷ 8 mm

**A021**

€ 136,00

PALPADOR CON RELOJ COMPARADOR Y BASE MAGNÉTICA

Para posicionar o restablecer la altura de herramientas, como fresas, directamente en las máquinas herramienta, determinando también la posición del husillo de la máquina.



Caja



Útil	0±2,40 mm 0±0,094"
Lectura	0,01 mm 0,0005"
Dimensiones plato	Ø 24 mm
Altura de dígitos	8 mm
Batería	1 x 3V CR2032
Dimensiones	Ø 50 x 51 mm

C061

€ 249,00

CENTRADOR DE DOS EJES

Con varilla de posicionamiento.



Caja

Comparador	Ø 40 mm
Recorrido	4,9 mm
Lectura	0,01 mm
Velocidad máx. de uso	800 rpm
Conexión cilíndrica	Ø 10 mm
Palpadores rectos	3
Palpadores curvos	3
Longitud palpadores	50 - 100 - 150 mm
Broca palpadora	Ø 3 mm
Marcador articulado	50 mm

C062

€ 41,20

CENTRADOR MECANICO FLOTANTE

Caja

Eje	Ø 10 mm
Palpadores	Ø 4 - 10 mm

C063

€ 78,90

CENTRADOR ELECTRONICO LUMINOSO

Caja

Eje	Ø 20 mm
Palpador	Ø 10 mm
Longitud total	100 mm
Alimentación	2 x SR44W

C063/L

€ 96,50

CENTRADOR ELECTRONICO LUMINOSO

Con sonido.



Caja

Eje	Ø 20 mm
Palpador	Ø 10 mm
Longitud total	160 mm
Alimentación	2 x LR1 1.5 V

M021-
MICRÓMETRO DIGITAL ELECTRÓNICO

Con fricción sobre el tambor, contactos en metal duro, funciones: abs/inc, set, on/off y mm/inch.



Caja

HM



863

Art.	€	Medida	Lectura	Precisión
M021/00/25	€ 101,00	0 ÷ 25 mm - 0 ÷ 1"	0,001 mm - 0,00005"	0,003 mm - 0,00015"
M021/25/50	€ 126,00	25 ÷ 50 mm - 1" ÷ 2"	0,001 mm - 0,00005"	0,003 mm - 0,00015"
M021/50/75	€ 153,00	50 ÷ 75 mm - 2" ÷ 3"	0,001 mm - 0,00005"	0,004 mm - 0,0002"
M021/75/100	€ 178,00	75 ÷ 100 mm - 3" ÷ 4"	0,001 mm - 0,00005"	0,004 mm - 0,0002"

M026-
MICROMETRO DIGITAL ELECTRONICO

Con fricción sobre el tambor.



Caja

HM



863

Art.	€	Medida	Lectura	Precisión
M026/0/25	€ 196,00	0 ÷ 25 mm - 0 ÷ 1"	0,001 mm 0,0001"	0,0002 mm 0,00008"
M026/25/50	€ 246,00	25 ÷ 50 mm - 1 ÷ 2"	0,001 mm 0,0001"	0,0002 mm 0,00008"
M026/50/75	€ 264,00	50 ÷ 75 mm - 2 ÷ 3"	0,001 mm 0,0001"	0,0003 mm 0,00012"
M026/75/100	€ 293,00	75 ÷ 100 mm - 3 ÷ 4"	0,001 mm 0,0001"	0,0003 mm 0,00012"

M022-
MICROMETRO CENTESIMAL DE EXTERIORES

Con tambor grande de 100 divisiones.



Caja

HM



863

Art.	€	Medida	Lectura	Precisión
M022/00/25	€ 74,40	0 ÷ 25 mm	0,01 mm	0,004 mm
M022/25/50	€ 92,50	25 ÷ 50 mm	0,01 mm	0,004 mm
M022/50/75	€ 109,00	50 ÷ 75 mm	0,01 mm	0,005 mm
M022/75/100	€ 125,00	75 ÷ 100 mm	0,01 mm	0,005 mm

M033
€ 216,00
SURTIDO DE MICRÓMETROS CENTESIMALES DE EXTERIORES

Contactos de metal duro y arco pintado.



Estuche de transporte

HM



863

Medida	0÷25 - 25÷50 - 50÷75 - 75÷100 - 100÷125 - 125÷150 mm
Lectura	0,01 mm
Precisión	0,004 - 0,004 - 0,005 - 0,005 - 0,006 - 0,006 mm
Vástago	Ø 6,3 mm

M033-
MICROMETRO CENTESIMAL DE EXTERIORES

Contactos de metal duro y arco pintado.



Caja

HM



863

Art.	€	Medida	Lectura	Vástago
M033/00/25	€ 27,20	0÷25 mm	0,01 mm	Ø 6,3 mm
M033/25/50	€ 38,20	25÷50 mm	0,01 mm	Ø 6,3 mm
M033/50/75	€ 42,70	50÷75 mm	0,01 mm	Ø 6,3 mm
M033/75/100	€ 47,30	75÷100 mm	0,01 mm	Ø 6,3 mm

M033-x
MICROMETRO CENTESIMAL DE EXTERIORES

Contactos de metal duro y arco pintado.



Caja

HM



863

Art.	€	Medida	Lectura	Vástago
M033/100/125	€ 50,60	100÷125 mm	0,01 mm	Ø 6,3 mm
M033/125/150	€ 54,00	125÷150 mm	0,01 mm	Ø 6,3 mm
M033/150/175	€ 64,50	150÷175 mm	0,01 mm	Ø 6,3 mm
M033/175/200	€ 73,50	175÷200 mm	0,01 mm	Ø 6,3 mm
M033/200/225	€ 85,30	200÷225 mm	0,01 mm	Ø 6,3 mm
M033/225/250	€ 104,00	225÷250 mm	0,01 mm	Ø 6,3 mm
M033/250/275	€ 107,00	250÷275 mm	0,01 mm	Ø 6,3 mm
M033/275/300	€ 121,00	275÷300 mm	0,01 mm	Ø 6,3 mm



M009-

MICROMETRO CENTESIMAL DE EXTERIORES

Contactos de metal duro y arco pintado.



HM



863

Art.	€	Medida	Lectura	Vástago
M009/300/400	€ 371,00	300 ÷ 400 mm	0,01 mm	ø 6,5 mm
M009/400/500	€ 405,00	400 ÷ 500 mm	0,01 mm	ø 6,5 mm
M009/500/600	€ 467,00	500 ÷ 600 mm	0,01 mm	ø 6,5 mm
M009/600/700	€ 556,00	600 ÷ 700 mm	0,01 mm	ø 6,5 mm
M009/700/800	€ 667,00	700 ÷ 800 mm	0,01 mm	ø 6,5 mm
M009/800/900	€ 770,00	800 ÷ 900 mm	0,01 mm	ø 6,5 mm
M009/900/1000	€ 915,00	900 ÷ 1000 mm	0,01 mm	ø 6,5 mm
M009/1000/1200	€ 1350,00	1000 ÷ 1200 mm	0,01 mm	ø 6,5 mm

M019-

MICROMETRO DE INTERIORES CON TRES CONTACTOS PARA AGUJEROS CIEGOS



Caja

Art.	€	Arandela	Medida	Lectura	Precisión
M019/06/08	€ 414,00	1	6 ÷ 8 mm	0,001 mm	0,004 mm
M019/08/10	€ 414,00	1	8 ÷ 10 mm	0,001 mm	0,004 mm
M019/10/12	€ 414,00	1	10 ÷ 12 mm	0,001 mm	0,004 mm
M019/12/16	€ 387,00	1	12 ÷ 16 mm	0,005 mm	0,004 mm
M019/16/20	€ 387,00	1	16 ÷ 20 mm	0,005 mm	0,004 mm
M019/20/25	€ 416,00	1	20 ÷ 25 mm	0,005 mm	0,004 mm
M019/25/30	€ 416,00	1	25 ÷ 30 mm	0,005 mm	0,004 mm
M019/30/40	€ 458,00	1	30 ÷ 40 mm	0,005 mm	0,004 mm
M019/40/50	€ 545,00	1	40 ÷ 50 mm	0,005 mm	0,005 mm
M019/50/63	€ 556,00	1	50 ÷ 63 mm	0,005 mm	0,005 mm
M019/62/75	€ 616,00	1	62 ÷ 75 mm	0,005 mm	0,005 mm
M019/75/88	€ 623,00	1	75 ÷ 88 mm	0,005 mm	0,005 mm
M019/87/100	€ 623,00	1	87 ÷ 100 mm	0,005 mm	0,005 mm
M019/100/125	€ 693,00	0	100 ÷ 125 mm	0,005 mm	0,005 mm
M019/125/150	€ 766,00	0	125 ÷ 150 mm	0,005 mm	0,005 mm

M010-

MICROMETRO A PLATILLO

Arco pintado.



863

Art.	€	Medida	Lectura	Platos
M010/0/25	€ 116,00	0 ÷ 25 mm	0,01 mm	Ø 20 mm
M010/25/50	€ 143,00	25 ÷ 50 mm	0,01 mm	Ø 20 mm
M010/50/75	€ 150,00	50 ÷ 75 mm	0,01 mm	Ø 20 mm
M010/75/100	€ 158,00	75 ÷ 100 mm	0,01 mm	Ø 20 mm
M010/100/125	€ 202,00	100 ÷ 125 mm	0,01 mm	Ø 27 mm
M010/125/150	€ 229,00	125 ÷ 150 mm	0,01 mm	Ø 27 mm
M010/150/175	€ 255,00	150 ÷ 175 mm	0,01 mm	Ø 27 mm
M010/175/200	€ 269,00	175 ÷ 200 mm	0,01 mm	Ø 27 mm

M019-x

SURTIDO DE MICRÓMETROS DE INTERIORES CON TRES CONTACTOS PARA AGUJEROS CIEGOS



Estuche de transporte



Art.	€	Micrómetros	Arandelas	Medida	Lectura	Precisión
M019/06/12	€ 1080,00	3	3	6 ÷ 12 mm	0,001 mm	0,004 mm
M019/12/20	€ 587,00	2	1	12 ÷ 20 mm	0,005 mm	0,004 mm
M019/20/40	€ 1140,00	3	2	20 ÷ 40 mm	0,005 mm	0,004 mm
M019/40/100	€ 2510,00	5	3	40 ÷ 100 mm	0,005 mm	0,005 mm

M013/0/100

€ 132,00

MICROMETRO CENTESIMAL DE PROFUNDIDAD



Estuche de transporte



Campo de medición	0÷25 mm, 25÷50 mm, 50÷75 mm, 75÷100 mm
Lectura	0,01 mm
Base	100 x 17 mm

B0x
SET DE CALAS DE CONTROL PARALELAS DE ACERO

Certificado de prueba emitido desde la fábrica, certificado Accredia a solicitud.



Estuche de transp



3650

Art.	€	Grado	Piezas	Medida nominal (mm)	Progresión (mm)	Pieza por paso
B008/1	€ 1130,00	1	8	25 - 50 - 75 - 100 - 250 - 300 - 400 - 500	-	1
B011/0	€ 233,00	0	11	2,5 - 5,1 - 7,7 - 10,3 - 12,9 - 15 - 17,6 - 20,2 - 22,8 - 23,4 - 25	-	1
B032/0	€ 471,00	0	32	1,005	-	1
				1,01±1,09	-	9
				1,1±1,9	0,01	9
				1±9	0,1	9
				10 - 20 - 30 - 50	1	4
B032/1	€ 292,00	1	32	1,005	-	1
				1,01±1,09	-	9
				1,1±1,9	0,01	9
				1±9	0,1	9
				10 - 20 - 30 - 50	1	4
B032/2	€ 163,00	2	32	1,005	-	1
				1,01±1,09	-	9
				1,1±1,9	0,01	9
				1±9	0,1	9
				10 - 20 - 30 - 50	1	4
B047/0	€ 669,00	0	47	1,005	-	1
				1,01±1,2	0,01	20
				1,3±1,9	0,1	7
				1±9	1	9
				10±100	10	10
B047/1	€ 396,00	1	47	1,005	-	1
				1,01±1,2	0,01	20
				1,3±1,9	0,1	7
				1±9	1	9
				10±100	10	10
B047/2	€ 235,00	2	47	1,005	-	1
				1,01±1,2	0,01	20
				1,3±1,9	0,1	7
				1±9	1	9
				10±100	10	10
B087/0	€ 1120,00	0	87	1,001±1,009	0,001	9
				1,01±1,49	0,01	49
				0,5±9,5	0,5	19
				10±100	10	10
				B087/1	€ 597,00	1
1,01±1,49	0,01	49				
0,5±9,5	0,5	19				
10±100	10	10				
B087/2	€ 365,00	2	87			
				1,01±1,49	0,01	49
				0,5±9,5	0,5	19
				10±100	10	10
				B103/0	€ 1280,00	0
1,01±1,49	0,01	49				
0,5±24,5	0,5	49				
25±100	25	4				
B103/1	€ 792,00	1	103			
				1,01±1,49	0,01	49
				0,5±24,5	0,5	49
				25±100	25	4
				B103/2	€ 447,00	2
1,01±1,49	0,01	49				
0,5±24,5	0,5	49				
25±100	25	4				
B112/0	€ 1120,00	0	112			
				1,001 ± 1,009	0,001	9
				1,01 ± 1,49	0,01	49
				0,5 ± 24,5	0,5	49
				25 ± 100	25	4
B112/1	€ 791,00	1	112	1,005	-	1
				1,001 ± 1,009	0,001	9
				1,01 ± 1,49	0,01	49
				0,5 ± 24,5	0,5	49
				25 ± 100	25	4



C025-

CALIBRE TAMPON LISO TOLERANCIA H7 TEMPLADO Y CEMENTADO



Art.	€	Ø	Piezas
C025/03	€ 37,60	3 mm	1
C025/04	€ 37,60	4 mm	1
C025/05	€ 37,60	5 mm	1
C025/06	€ 37,60	6 mm	1
C025/07	€ 37,60	7 mm	1
C025/08	€ 37,60	8 mm	1
C025/09	€ 37,60	9 mm	1
C025/10	€ 37,60	10 mm	1
C025/11	€ 46,60	11 mm	1
C025/12	€ 46,60	12 mm	1
C025/13	€ 46,60	13 mm	1
C025/14	€ 46,60	14 mm	1
C025/15	€ 46,60	15 mm	1
C025/16	€ 46,60	16 mm	1
C025/17	€ 46,60	17 mm	1
C025/18	€ 46,60	18 mm	1
C025/19	€ 46,60	19 mm	1
C025/20	€ 46,60	20 mm	1
C025/21	€ 69,80	21 mm	1
C025/22	€ 69,80	22 mm	1
C025/23	€ 69,80	23 mm	1
C025/24	€ 69,80	24 mm	1
C025/25	€ 69,80	25 mm	1
C025/26	€ 69,80	26 mm	1
C025/27	€ 69,80	27 mm	1
C025/28	€ 69,80	28 mm	1
C025/29	€ 69,80	29 mm	1
C025/30	€ 87,50	30 mm	1
C025/32	€ 87,50	32 mm	1
C025/33	€ 87,50	33 mm	1
C025/34	€ 87,50	34 mm	1
C025/35	€ 87,50	35 mm	1
C025/36	€ 87,50	36 mm	1
C025/37	€ 87,50	37 mm	1
C025/38	€ 87,50	38 mm	1
C025/40	€ 87,50	40 mm	1
C025/42	€ 87,50	42 mm	1
C025/44	€ 87,50	44 mm	1
C025/45	€ 98,30	45 mm	1
C025/46	€ 98,40	46 mm	1
C025/47	€ 98,40	47 mm	1
C025/48	€ 98,40	48 mm	1
C025/50	€ 98,40	50 mm	1
C025/51	€ 106,00	51 mm	1
C025/52	€ 106,00	52 mm	1
C025/55	€ 106,00	55 mm	2
C025/56	€ 106,00	56 mm	2
C025/57	€ 106,00	57 mm	2
C025/58	€ 106,00	58 mm	2
C025/59	€ 106,00	59 mm	2
C025/60	€ 106,00	60 mm	2
C025/62	€ 127,00	62 mm	2
C025/63	€ 127,00	63 mm	2
C025/65	€ 127,00	65 mm	2
C025/66	€ 127,00	66 mm	2
C025/67	€ 127,00	67 mm	2
C025/68	€ 127,00	68 mm	2
C025/69	€ 127,00	69 mm	2
C025/70	€ 169,00	70 mm	2
C025/71	€ 169,00	71 mm	2
C025/72	€ 169,00	72 mm	2
C025/74	€ 169,00	74 mm	2
C025/75	€ 169,00	75 mm	2
C025/76	€ 169,00	76 mm	2
C025/78	€ 169,00	78 mm	2
C025/80	€ 169,00	80 mm	2

C025-3x

SET DE CALIBRES TAMPONES H7 LISOS, TEMPLADOS Y CEMENTADOS



Estuche de trans

Art.	€	Piezas	Paso	Ø
C025/3/30	€ 1190,00	28	1 mm	3 + 30 mm
C025/32/62	€ 1420,00	16	-	32-35-37-38-40-42-45-47-48-50 52-55-56-58-60-62 mm

A015-

ANILLO DE AJUSTE A CERO

Precision 6g.



2250

Art.	€	Medida
A015/008	€ 57,00	8 mm
A015/010	€ 63,90	10 mm
A015/011	€ 63,90	11 mm
A015/017	€ 69,80	17 mm
A015/025	€ 69,80	25 mm
A015/035	€ 69,80	35 mm
A015/040	€ 119,00	40 mm
A015/062	€ 132,00	62 mm
A015/087	€ 311,00	87 mm
A015/100	€ 327,00	100 mm
A015/125	€ 506,00	125 mm
A015/150	€ 710,00	150 mm

T048x
CALIBRE TAMPON DE ROSCAS PASA Y NO PASA

Paso gas cilíndrico.



Art.	€	Dimensiones
T0481/8	€ 70,80	1/8" - 28 TPI
T0481/4	€ 70,80	1/4" - 19 TPI
T0483/8	€ 70,80	3/8" - 19 TPI
T0481/2	€ 91,10	1/2" - 14 TPI
T0485/8	€ 106,00	5/8" - 14 TPI
T0483/4	€ 113,00	3/4" - 14 TPI
T0487/8	€ 147,00	7/8" - 14 TPI
T0481	€ 172,00	1" - 11 TPI

T049x
CALIBRE TAMPON DE ROSCAS PASA Y NO PASA

Art.	€	Dimensiones
T0493X0.5	€ 64,90	3 x 0,5 mm
T0494X0.7	€ 83,50	4 x 0,7 mm
T0495X0.8	€ 86,40	5 x 0,8 mm
T0496X1	€ 86,40	6 x 1 mm
T0498X1	€ 78,70	8 x 1 mm
T0498X1.25	€ 78,70	8 x 1,25 mm
T04910X1	€ 80,50	10 x 1 mm
T04910X1.25	€ 80,50	10 x 1,25 mm
T04910X1.5	€ 80,50	10 x 1,5 mm
T04912X1.25	€ 80,50	12 x 1,25 mm
T04912X1.5	€ 80,50	12 x 1,5 mm
T04912X1.75	€ 80,50	12 x 1,75 mm
T04914X1.5	€ 86,40	14 x 1,5 mm
T04914X2	€ 86,40	14 x 2 mm
T04916X1.5	€ 90,20	16 x 1,5 mm
T04916X2	€ 90,20	16 x 2 mm
T04918X1.5	€ 66,90	18 x 1,5 mm
T04918X2.5	€ 66,90	18 x 2,5 mm
T04920X1.5	€ 73,30	20 x 1,5 mm
T04920X2.5	€ 73,30	20 x 2,5 mm
T04922X1.5	€ 75,10	22 x 1,5 mm
T04922X2.5	€ 75,10	22 x 2,5 mm
T04924X1.5	€ 78,70	24 x 1,5 mm
T04924X2	€ 78,70	24 x 2 mm
T04924X3	€ 78,70	24 x 3 mm

A018x
ANILLO ROSCADO PASA

Paso gas cilíndrico.



Art.	€	Dimensiones
A0181/8	€ 73,00	1/8" - 28 TPI
A0181/4	€ 73,00	1/4" - 19 TPI
A0183/8	€ 73,00	3/8" - 19 TPI
A0181/2	€ 100,00	1/2" - 14 TPI
A0185/8	€ 100,00	5/8" - 14 TPI
A0183/4	€ 122,00	3/4" - 14 TPI
A0187/8	€ 147,00	7/8" - 14 TPI
A0181	€ 107,00	1" - 11 TPI

A017x
ANILLO ROSCADO METRICO

Art.	€	Dimensiones
A0173X0.5	€ 62,90	3 x 0,5 mm
A0174X0.7	€ 70,80	4 x 0,7 mm
A0175X0.8	€ 70,80	5 x 0,8 mm
A0176X1	€ 58,90	6 x 1 mm
A0178X1	€ 58,90	8 x 1 mm
A0178X1.25	€ 58,90	8 x 1,25 mm
A01710X1	€ 83,50	10 x 1 mm
A01710X1.25	€ 64,90	10 x 1,25 mm
A01710X1.5	€ 64,90	10 x 1,5 mm
A01712X1.25	€ 90,20	12 x 1,25 mm
A01712X1.5	€ 90,20	12 x 1,5 mm
A01712X1.75	€ 90,20	12 x 1,75 mm
A01714X2	€ 90,20	14 x 2 mm
A01716X1.5	€ 95,60	16 x 1,5 mm
A01716X2	€ 95,60	16 x 2 mm
A01718X1.5	€ 66,90	18 x 1,5 mm
A01718X2.5	€ 66,90	18 x 2,5 mm
A01720X1.5	€ 70,60	20 x 1,5 mm
A01720X2.5	€ 70,60	20 x 2,5 mm
A01722X1.5	€ 80,40	22 x 1,5 mm
A01722X2.5	€ 80,40	22 x 2,5 mm
A01724X1.5	€ 107,00	24 x 1,5 mm
A01724X2	€ 107,00	24 x 2 mm
A01724X3	€ 107,00	24 x 3 mm

S091
€ 520,00
SET DE GALGAS CALIBRADAS

Estuche de trans

Piezas	91
Medida	1±10 mm
Progresión	0,1 mm
Longitud	50 mm
Dureza	HRC-60-62
Precisión	±0,002 mm



**T009**

€ 35,00

SOPORTE PALPADOR BUSCACENTROS

Estuche de transporte



Conexión macho	Ø 8 mm
Conexión hembra	Ø 4 mm

B201/2

€ 21,60

BASE MAGNETICA

Para portacomparador, material magnético n35, interruptor en abs y base prismatica.



Estuche de transporte



Dimensiones base	60 x 50 x 55 mm
Orificio	M8 x 1,25
Fuerza magnetica	800 N

B201/4

€ 39,80

BASE MAGNETICA

Para portacomparador, material magnético n35, interruptor en abs y base prismatica.



Estuche de transporte



Dimensiones base	117 x 50 x 55 mm
Orificio	M8 x 1,25
Fuerza magnetica	1300 N

S052/2

€ 34,20

SOPORTE MAGNETICO PORTACOMPARADORE

Con ajuste micrométrico, columna robusta y brazo ajustable. Base magnética con soporte prismático.



Estuche de transporte



Barra principal	Ø 12 x 176 mm
Barra secundaria	Ø 10 x 150 mm
Fuerza magnetica	800 N
Dimensiones base	60 x 50 x 55 mm

B201/1

€ 18,20

BASE MAGNETICA

Para portacomparador, material magnético n35, interruptor en abs y base prismatica.



Estuche de transporte



Dimensiones base	36 x 30 x 35 mm
Orificio	M5 x 0,8
Fuerza magnetica	300 N

B201/3

€ 28,50

BASE MAGNETICA

Para portacomparador, material magnético n35, interruptor en abs y base prismatica.



Estuche de transporte



Dimensiones base	73 x 50 x 55 mm
Orificio	M8 x 1,25
Fuerza magnetica	1000 N

B100

€ 26,00

BASE MAGNETICA

Para portacomparador, interruptor en abs y base prismatica.



Estuche de transporte



Dimensiones	63 x 50 x 55 mm
Orificio	M8 x 1,25
Fuerza magnetica	600 N

S052/3

€ 59,30

SOPORTE MAGNETICO PORTACOMPARADORE

Con ajuste micrométrico, columna robusta y brazo ajustable. Base magnética con soporte prismático.



Estuche de transporte



Barra principal	Ø 16 x 225 mm
Barra secundaria	Ø 14 x 165 mm
Fuerza magnetica	1000 N
Dimensiones base	73 x 50 x 55 mm

S052/4
€ 87,80
SOPORTE MAGNETICO PORTACOMPARADORE

Con ajuste micrométrico, columna robusta y brazo ajustable. Base magnética con soporte prismático.



Caja

Barra principal	∅ 20 x 355 mm
Barra secundaria	∅ 14 x 210 mm
Fuerza magnetica	1300 N
Dimensiones base	117 x 50 x 55 mm

S049
€ 38,60
SOPORTE MAGNÉTICO PORTACOMPARADOR

Con regulación micrométrica.



Caja

Barra principal	∅ 12 x 170 mm
Barra secundaria	∅ 10 x 150 mm
Fuerza magnetica	600 N
Dimensiones base	63 x 50 x 55h mm

S047
€ 72,30
SOPORTE MAGNÉTICO PORTACOMPARADOR

Con regulación micrométrica.



Caja

Barra principal	∅ 16 x 220 mm
Barra secundaria	∅ 12 x 180 mm
Fuerza magnetica	800 N
Dimensiones base	65 x 50 x 55h mm

S054
€ 35,00
SOPORTE MAGNÉTICO PORTACOMPARADOR

Caja

Barra principal	∅ 12 x 170 mm
Barra secundaria	∅ 10 x 165 mm
Fuerza magnetica	600 N
Dimensiones base	63 x 50 x 55h mm

S055
€ 68,30
SOPORTE MAGNÉTICO PORTACOMPARADOR

Caja

Barra principal	∅ 16 x 210 mm
Barra secundaria	∅ 12 x 175 mm
Fuerza magnetica	800 N
Dimensiones base	75 x 50 x 55h mm

S042/1
€ 63,10
SOPORTE MAGNÉTICO ARBOLADURA MECÁNICA

Con bloqueo central 3d.



Caja

Dimensiones base	36 x 30 x 35 mm
Fuerza magnetica	300 N
Longitud brazo	145 mm

S042/2
€ 79,80
SOPORTE MAGNÉTICO ARBOLADURA MECÁNICA

Con ajuste micrométrico y bloqueo central 3d.



Caja

Dimensiones base	60 x 50 x 55 mm
Fuerza magnetica	800 N
Longitud brazo	290 mm

S042/3
€ 103,00
SOPORTE MAGNETICO ARBOLADURA MECANICA

Con ajuste micrometrico y bloqueo central 3d.



Caja

Dimensiones base	75 x 50 x 55 mm
Fuerza magnetica	1000 N
Longitud brazo	365 mm



**S045**

€ 81,00

SOPORTE MAGNÉTICO ARBOLADURA MECÁNICA

Caja

Barra principal	Ø 12 x 160 mm
Barra secundaria	Ø 10 x 180 mm
Fuerza magnetica	600 N
Dimensiones base	63 x 50 x 55h mm

**S046**

€ 124,00

SOPORTE MAGNÉTICO ARBOLADURA HIDRÁULICA

Caja

Barra principal	Ø 17 x 180 mm
Barra secundaria	Ø 14 x 200 mm
Fuerza magnetica	600 N
Dimensiones base	63 x 50 x 55h mm

**B025**

€ 239,00

MESA DE MEDICIÓN

Con plano ranurados y banco de aluminio.



Caja

Porta comparador	Ø 8 mm
Dimensiones superficie	80 x 80 mm
Dimensiones base	150 x 100 mm
Columna	Ø 25 x 180 mm

**B010**

€ 295,00

MESA DE MEDICION

Con banco de granito.



Caja

Porta comparador	Ø 8 mm
Dimensiones base	300 x 200 x 50h mm
Columna	Ø 35 x 300 mm
Planitud base	0,002 mm

**A019-****BANCO DE CONCENTRICIDAD**

Superficie rectificaday equipado con soporte porta comparadores.



Caja de madera



Hierro fundido



Art.	€	Distancia entre puntas	Altura brocas Min. - Máx.	CM	Dimensiones	Porta comparador	Peso neto
A019/300	€ 1340,00	300 mm	145 / 175 mm	2	730 x 310 x 370h mm	2	65 kg
A019/500	€ 1710,00	500 mm	135 / 170 mm	2	924 x 330 x 482h mm	2	70 kg
A019/1000	€ 2020,00	1000 mm	135 / 170 mm	2	1400 x 330 x 430h mm	2	100 kg

S051

€ 34,60

SOPORTE PARA MICROMETRO

Con bocas recubiertas de plastico suave.



Caja



Hierro fundido



P04x
MARMOL DE VERIFICACION EN GRANITO

Grado 0



Caja de madera

Art.	€	Dimensiones	Peso neto
P040	€ 96,10	310 x 230 x 80 mm	20 kg
P042	€ 308,00	630 x 400 x 100 mm	80 kg
P043	€ 825,00	1000 x 630 x 150 mm	280 kg
P047	€ 1370,00	1200 x 800 x 160 mm	497 kg
P044	€ 2900,00	1600 x 1000 x 200 mm	1059 kg

S06x
ESCUADRA DE GRANITO

Grado 0



Caja de madera



876

Art.	€	Dimensiones	Precisión
S061	€ 458,00	250 x 40 x 400h mm	± 6 µm
S062	€ 646,00	400 x 100 x 635h mm	± 9 µm

S050-
ESCUADRA 90°

Adecuado para comprobar la cuadratura y la planitud en la industria mecánica de precisión. Con alas



Acero



875/1

Art.	€	Dimensiones	Sección
S050/150	€ 36,80	150 x 100 mm	25,5 x 4,8 mm
S050/200	€ 46,70	200 x 130 mm	30,3 x 6 mm
S050/250	€ 62,40	250 x 165 mm	35 x 7 mm
S050/300	€ 69,50	300 x 200 mm	36 x 9 mm
S050/400	€ 154,00	400 x 265 mm	39 x 9 mm
S050/500	€ 184,00	500 x 330 mm	50 x 9 mm

S051-
ESCUADRA 90°

Adecuado para comprobar la cuadratura y la planitud en la industria mecánica. Con alas



Acero

Art.	€	Dimensiones	Sección
S051/100	€ 15,70	100 x 70 mm	20 x 5,5 mm ²
S051/150	€ 18,10	150 x 100 mm	20 x 5,5 mm ²
S051/200	€ 24,80	200 x 130 mm	20 x 5,5 mm ²
S051/250	€ 28,60	250 x 160 mm	25 x 5,5 mm ²
S051/300	€ 36,90	300 x 175 mm	25 x 5,5 mm ²
S051/400	€ 40,60	400 x 200 mm	29,5 x 5,5 mm ²
S051/500	€ 62,40	500 x 250 mm	29,5 x 5,5 mm ²
S051/600	€ 78,50	600 x 330 mm	29,5 x 5,5 mm ²
S051/750	€ 185,00	750 x 375 mm	29,5 x 5,5 mm ²
S051/1000	€ 221,00	1000 x 500 mm	29,5 x 5,5 mm ²

S059-
ESCUADRA 90°

Adecuado para comprobar la cuadratura y la planitud en la industria mecánica. Sin alas



Acero

Art.	€	Dimensiones	Sección
S059/100	€ 9,10	100 x 70 mm	20 x 5,5 mm ²
S059/150	€ 10,90	150 x 100 mm	20 x 5,5 mm ²
S059/200	€ 12,70	200 x 130 mm	20 x 5,5 mm ²
S059/250	€ 15,30	250 x 160 mm	25 x 5,5 mm ²
S059/300	€ 17,50	300 x 175 mm	25 x 5,5 mm ²
S059/400	€ 22,20	400 x 200 mm	29,5 x 5,5 mm ²
S059/500	€ 26,40	500 x 250 mm	29,5 x 5,5 mm ²
S059/600	€ 31,70	600 x 330 mm	29,5 x 5,5 mm ²
S059/750	€ 54,40	750 x 375 mm	29,5 x 5,5 mm ²
S059/1000	€ 79,30	1000 x 500 mm	29,5 x 5,5 mm ²

S048-

ESCUADRA 90° BISELADA



875/00

Art.	€	Dimensiones	Sección
S048/100	€ 39,10	100 x 70 mm	20 x 5 mm ²
S048/150	€ 59,30	150 x 100 mm	25 x 5 mm ²

S056-

ESCUADRA MAGNÉTICA DE 90°



Caja

Art.	€	Dimensiones	Fuerza magnética max.
S056/150	€ 90,30	150 x 150 x 50 mm	500 N
S056/200	€ 113,00	200 x 200 x 50 mm	1000 N

S057/125

POSICIONADOR MAGNÉTICO

€ 21,00



Blister

Dimensiones	135 x 135 x 25 mm
Fuerza magnetica	340 N
Ángulo de posicionamiento	45 - 90 - 135°

0286-

ESCUADRA MILIMETRADA DE CARPINTERO



Art.	€	Dimensiones
0286/250	€ 3,11	250 x 130 x 0,8 mm
0286/300	€ 3,66	300 x 130 x 0,8 mm
0286/350	€ 4,08	350 x 155 x 0,8 mm

S058

ESCUADRA MAGNETICA REGULABLE

€ 104,00



Caja

Dimensiones	115 x 115 x 35 mm
Grados	45° ± 90°
Fuerza magnética max.	250 N

S057/060S

POSICIONADORES MAGNETICOS

€ 14,20



4 Pcs



Blister

Dimensiones	50 x 60 x 12,5 mm
Fuerza magnetica	45 N
Ángulo de posicionamiento	45 - 90 - 135°

0212 € 8,80

GALGA DE ESPESOR



Blister

Hojas núm.	20
Medidas	0,05 - 1,00 mm

FGx-AI

JUEGO GALGA DE ESPESORES DE ACERO INOX

Cuchillas de forma cónica, caja niquelada con tuerca de seguridad, medidas en mm y pulgadas en cada cuchilla.



Blister

INOX

Art.	€	Hojas núm.	Tolerancia	Medidas	Longitud hoja
FG01/AI	€ 14,40	13	T2	0,05 - 1,00 mm 0,002 - 0,040"	100 mm
FG02/AI	€ 22,90	20	T2	0,05 - 1,00 mm 0,002 - 0,040"	100 mm

HT125 € 7,70

SOPORTE PARA ROLLO FLEJE CALIBRADO



Blister

Dimensiones	125 x 17 mm
-------------	-------------



FGx

JUEGO GALGA DE ESPESORES

Cuchillas de forma cónica, caja niquelada con tuerca de seguridad, medidas en mm y pulgadas en cada cuchilla.



Blister



Acero

Art.	€	Hojas núm.	Tolerancia	Medidas	Longitud hoja
FG01	€ 4,85	13	T2	0,05 - 1,00 mm 0,002 - 0,040"	100 mm
FG02	€ 8,20	20	T2	0,05 - 1,00 mm 0,002 - 0,040"	100 mm

TGx-AE

ROLLO FLEJE CALIBRADO

Mida en mm y pulgadas en cada cuchilla. Tolerancia T2



Blister



Acero

Art.	€	Espesor	Longitud
TG001/AE	€ 66,80	0.01 mm 0.0004"	5 m
TG002/AE	€ 51,80	0.02 mm 0.0008"	5 m
TG003/AE	€ 28,50	0.03 mm 0.0012"	5 m
TG004/AE	€ 29,60	0.04 mm 0.0016"	5 m
TG005/AE	€ 20,70	0.05 mm 0.0020"	5 m
TG006/AE	€ 20,70	0.06 mm 0.0024"	5 m
TG007/AE	€ 20,70	0.07 mm 0.0028"	5 m
TG008/AE	€ 20,70	0.08 mm 0.0032"	5 m
TG009/AE	€ 20,70	0.09 mm 0.0035"	5 m
TG010/AE	€ 20,70	0.10 mm 0.0040"	5 m
TG012/AE	€ 20,70	0.12 mm 0.005"	5 m
TG015/AE	€ 19,10	0.15 mm 0.006"	5 m
TG018/AE	€ 20,70	0.18 mm 0.007"	5 m
TG020/AE	€ 19,10	0.20 mm 0.008"	5 m
TG025/AE	€ 19,10	0.25 mm 0.010"	5 m
TG030/AE	€ 19,10	0.30 mm 0.012"	5 m
TG035/AE	€ 20,70	0.35 mm 0.014"	5 m
TG040/AE	€ 20,70	0.40 mm 0.016"	5 m
TG045/AE	€ 20,70	0.45 mm 0.018"	5 m
TG050/AE	€ 20,70	0.50 mm 0.020"	5 m
TG055/AE	€ 29,60	0.55 mm 0.022"	5 m
TG060/AE	€ 29,60	0.60 mm 0.024"	5 m
TG065/AE	€ 29,60	0.65 mm 0.026"	5 m
TG070/AE	€ 25,50	0.70 mm 0.028"	5 m
TG075/AE	€ 25,50	0.75 mm 0.030"	5 m
TG080/AE	€ 25,50	0.80 mm 0.032"	5 m
TG085/AE	€ 25,50	0.85 mm 0.034"	5 m
TG090/AE	€ 25,50	0.90 mm 0.036"	5 m
TG095/AE	€ 25,50	0.95 mm 0.038"	5 m
TG100/AE	€ 25,50	1.00 mm 0.040"	5 m
TG110/AE	€ 19,40	1.10 mm	1 m
TG120/AE	€ 19,40	1.20 mm	1 m
TG130/AE	€ 19,40	1.30 mm	1 m
TG140/AE	€ 19,40	1.40 mm	1 m
TG150/AE	€ 19,40	1.50 mm	1 m
TG160/AE	€ 19,40	1.60 mm	1 m
TG170/AE	€ 19,40	1.70 mm	1 m
TG180/AE	€ 19,40	1.80 mm	1 m
TG190/AE	€ 19,40	1.90 mm	1 m
TG200/AE	€ 19,40	2.00 mm	1 m

**C058**

€ 14,00

GALGA DE ROSCAS 58 HOJAS

Blister

Hojas métricas	0.25 - 6 mm 60°
Hojas en pulgadas	4 - 62 TPI 55°
Hojas a gas	8 - 28 TPI 55°

C029-**COMPAS**

Para interiores



Art.	€	Longitud
C029/150	€ 9,70	150 mm
C029/200	€ 12,00	200 mm
C029/250	€ 13,90	250 mm
C029/300	€ 16,40	300 mm

C027-**COMPAS**

De brazos cuadrados con guía y freno



Art.	€	Longitud
C027/150	€ 13,50	150 mm
C027/200	€ 15,90	200 mm
C027/250	€ 19,80	250 mm
C027/300	€ 22,00	300 mm

C026-**COMPAS**

De brazos cuadrados con puntas



Art.	€	Longitud
C026/150	€ 9,70	150 mm
C026/200	€ 12,00	200 mm
C026/250	€ 16,40	250 mm
C026/300	€ 18,90	300 mm

C028-**COMPAS**

Para exteriores



Art.	€	Longitud
C028/150	€ 9,70	150 mm
C028/200	€ 12,00	200 mm
C028/250	€ 13,90	250 mm
C028/300	€ 16,40	300 mm



P007-
PRISMA MAGNETICO

En unidad o pareja



Caja

Art.	€	Dimensiones	Anchura	Fuerza magnética max.	Piezas
P007/1	€ 123,00	70 x 60 x 72 mm	38 mm	400 N	1
P007/2	€ 158,00	100 x 70 x 95 mm	50 / 16 mm	300 N	1
P007/1C	€ 234,00	71 x 60 x 73 mm	38 mm	400 N	2
P007/2C	€ 360,00	100 x 70 x 95 mm	50 / 16 mm	300 N	2

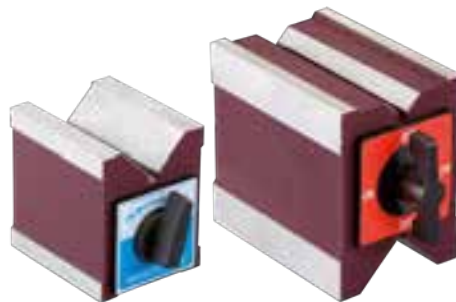
P30x
SOPORTE DE ACERO EN "V"

Con brida en unidad o pareja.



Caja



Acero



Templado

Art.	€	Dimensiones	Bloqueo máximo	Precisión	Piezas
P301/2	€ 68,90	63,5 x 63,5 x 50 mm	ø 35 mm	±0,01 mm	1
P302/2	€ 117,00	100 x 75 x 75 mm	ø 65 mm	±0,01 mm	1
P303/2	€ 181,00	150 x 125 x 100 mm	ø 110 mm	±0,01 mm	1
P301/2C	€ 133,00	63,5 x 63,5 x 50,8 mm	ø 35 mm	±0,01 mm	2
P302/2C	€ 230,00	100 x 75 x 75 mm	ø 65 mm	±0,01 mm	2
P303/2C	€ 361,00	150 x 125 x 100 mm	ø 110 mm	±0,01 mm	2

P20x
PAREJA SOPORTES EN "V"

Caja

C45

Art.	€	Dimensiones	Precisión
P200/1	€ 251,00	75 x 75 x 60 mm	1/100 mm
P201/1	€ 334,00	100 x 80 x 60 mm	1/100 mm

P011-
PRISMA ANGULAR

Caja

Art.	€	Dimensiones
P011/075	€ 116,00	75 x 32 x 25 mm
P011/100	€ 138,00	102 x 48 x 46 mm



F813

€ 4,90 **NEW**

FLEXOMETRO



Expositor

Dimensiones correa
Clase de precisión

3m x 12 mm
II

F2Gx

FLEXOMETRO

Con freno en acero, gancho en el extremo remachado con protector de la hoja inferior con amortiguador.



Expositor

Art.	€	Dimensiones correa	Clase de precisión
F2G2	€ 3,58	2 m x 16 mm	II
F2G3	€ 4,09	3 m x 16 mm	II
F2G5	€ 6,30	5 m x 19 mm	II

F68x

FLEXOMETRO MAGNÉTICO

Con freno en acero, gancho en el extremo remachado con protector de la hoja inferior con amortiguador.



Expositor

Art.	€	Dimensiones correa	Clase de precisión
F683	€ 6,70	3 m x 19 mm	II
F685	€ 9,30	5 m x 25 mm	II
F688	€ 13,40	8 m x 25 mm	II

F80x

FLEXOMETRO

Forma ergonomica, anti-corte, con bloque de seguridad, hebilla para cinturon, gancho magnetica, revestido en poliester anti-abrasivo.



Expositor

Art.	€	Dimensiones correa	Clase de precisión
F802	€ 2,83	2 m x 16 mm	II
F803	€ 4,60	3 m x 16 mm	II
F805	€ 6,50	5 m x 19 mm	II
F808	€ 9,30	8 m x 25 mm	II

F32x

FLEXOMETRO MAGNÉTICO

Con freno automatico e iman.



Expositor

Art.	€	Dimensiones correa	Clase de precisión
F322	€ 4,61	2 m x 16 mm	II
F323	€ 6,10	3 m x 19 mm	II
F325	€ 8,30	5 m x 25 mm	II
F328	€ 11,60	8 m x 25 mm	II

R0x

CINTA METRICA

De acero.



Caja

Art.	€	Dimensiones correa
R030	€ 28,10	30 m x 13 mm
R050	€ 43,60	50 m x 13 mm

0449

€ 25,60

MINI NIVEL LASER

Con 4 burbujas, cuerpo en ABS y láser capaz de emitir un solo punto o una línea transversal/perpendicular.



Caja

Tipo láser	Clase II / 650 nm
Distancia de trabajo	20 m
Potencia	< 1 mW
Precisión	0,05°
Batería	2 x 1,5V AAA

0109

€ 52,70

NIVEL DIGITAL

Magnética con cuerpo de aluminio, apagado automático, retroiluminación, dos burbujas, lectura absoluta y relativa, función "hold".



Caja

Longitud	400 mm
Auto apagado	5 min
Gama de medición	0 - 90° x 4
Resolución	0° - 90°: 0,1°
Precisión nivel	0° - 90°: ±0,2°
Batería	2 x AAA 1,5V

0646/A

€ 128,00

NIVEL LASER AUTONIVELANTE



Caja

Precisión de nivelación	0,5 mm / m
Precisión línea horizontal y vertical	± 0,5 mm / m
Batería	3 x 1,5V AA
Tipo láser	Clase II / 650 nm
Distancia de trabajo recomendada	10 m
H máxima	126,5 cm
H mínima	52,5 cm

0666

€ 193,00

NIVEL DIGITAL CON RAYO LÁSER

Visualización del ángulo en grados y porcentaje. Pilas no incluidas.



Caja

Longitud	600 mm
Auto apagado	5 min
Gama de medición	0 - 360°
Longitud de onda	650 nm
Resolución	0,1°
Potencia láser	< 1 mW
Precisión nivel	± 0,05°
Precisión del punto	±1 mm / m
Batería	2 x 1,5V AAA

0112

€ 115,00

NIVEL DIGITAL

Magnético con cuerpo de aluminio y superficie de base fresada, apagado automático, retroiluminación, dos burbujas, función "hold", 0° y 90° sonoro, lectura: absoluta y relativa, ángulo, porcentaje, mm/m y in/ft, bolsa de transporte.



Caja

Longitud	600 mm
Auto apagado	5 min
Gama de medición	0 - 90° x 4
Resolución	0° & 90°: 0,05°; 0° - 89°: 0,1°
Precisión nivel	0° & 90°: ±0,05°; 0,1° - 89,9°: ±0,2°
Batería	2 x AAA 1,5 V

L090A € 120,00

NIVEL DIGITAL INCLINÓMETRO Y GONIÓMETRO CON IMÁN

Lectura de 0 ÷ 90° en las cuatro direcciones, lectura en mm/m y in/ft, inclinación en ((%)) porcentaje, medidas absoluta (ABS) y relativa, inversión automática de los dígitos (lectura arriba y abajo), retro iluminación y auto apagado, señal acústica a 0° y 90°.



Caja

Precisión	± 0.15°
Gama de medición	0 ÷ 90° x 4
Resolución	0.05°
Dimensiones	151 x 31 x 60 mm
Batería	2 x 1.5 V AAA

L085 € 91,70

NIVEL CUADRA DIGITAL

Magnético, digital de ±0 ÷ 180°, medición absoluta (ABS) y relativa, inversión de los dígitos para lectura arriba y abajo, paro automático, función mantener.



Blister



Precisión	± 0.1°
Gama de medición	0° ÷ 180°
Resolución	0.1°
Dimensiones	51 x 51 x 33 mm
Batería	1 x 3 V CR2032

0824-

NIVEL

De aluminio de 3 burbujas, milimetrado y fresado en la base.



Art.	€	Dimensiones
0824/300	€ 6,10	300 x 49 x 23 mm
0824/400	€ 6,90	400 x 49 x 23 mm
0824/500	€ 8,10	500 x 49 x 23 mm
0824/600	€ 9,20	600 x 49 x 23 mm

L080 € 58,20

NIVEL CUADRA DIGITAL

Magnético, digital de 0 ÷ 90° en las cuatro direcciones, retro-iluminación, medición absoluta (ABS) y relativa, inversión de los dígitos para lectura arriba y abajo, paro automático.



Blister

Precisión	0° ± 0.1°; 90° ± 0.1°; 0.1° ÷ 89.9° ± 0.2°
Gama de medición	0 ÷ 90° x 4
Resolución	0.1°
Dimensiones	59 x 27 x 59 mm
Batería	1 x 1.5 V AAA

0805/400 € 10,00

NIVEL MAGNETICO

Milimetrado de 3 burbujas.



Dimensiones	400 x 50 x 20 mm
-------------	------------------

L200 € 206,00

NIVEL LINEAL

De precisión con base prismática.



Dimensiones	200 x 45 x 40 mm
Precisión	0,02 mm / m

L150

€ 239,00

NIVEL CUADRADO

De alta precisión con 2 caras lisas y 2 prismáticas.



Dimensiones	150 x 38 x 150 mm
Precisión	0,02 mm / m

G006-

GONIOMETRO SIMPLE ACERO

Con tornillo de bloqueo, escala grabada con láser.

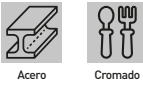

Art.	€	Arco	Barra	Campo de medición
G006/120	€ 23,00	Ø 80 mm	120 mm	0 ÷ 180°
G006/150	€ 25,80	Ø 120 mm	150 mm	0 ÷ 180°
G006/200	€ 31,30	Ø 150 mm	200 mm	0 ÷ 180°
G006/300	€ 43,90	Ø 200 mm	300 mm	0 ÷ 180°
G006/500	€ 90,50	Ø 300 mm	500 mm	0 ÷ 180°
G006/600	€ 103,00	Ø 300 mm	600 mm	0 ÷ 180°

G008

€ 55,90

GONIÓMETRO DIGITAL Y NIVEL CON 2 BURBUJAS

Cálculo automático de los ángulos e inclinaciones.



Blister

Longitud	400 mm
Escala	0 ÷ 225°
Lectura	0,1°
Precisión	± 0,5°
Batería	1x 9V

G005

€ 93,60

GONIOMETRO UNIVERSAL



Lectura	5'
Escala	0° ÷ 360°
Barra	300 mm



E022/12
€ 382,00
ENDOSCOPIO FLEXIBLE PARA USO MECANICO

Con sonda \varnothing 12 mm equipado con: pantalla lcd color de 3,5", sonda flexible, cámara equipada con luces Led, es posible agregar hasta 2 extensiones, terminal magnético, terminal a gancho.



Estuche de transporte

Longitud sin mango	900 mm
Sonda	\varnothing 12 mm
Visión	0° - 60°
Batería	1 x 9 V
Máxima profundidad de detección	50 mm
Distancia	2.5 cm - 30 cm
Pantalla	3.5" LCD
Tiempo de uso	> 2hr
Temperatura de funcionamiento	0°C - 45°C
Temperatura almacenamiento	-20°C - +60°C
Dimensiones	215 x 156 x 96 mm

M072
€ 31,50
LUPA DE PRECISION PARA MEDIR

Caja

Aumentos	10x
Campo de visión	24 mm
Campo de medición	0 \pm 20 mm
Lectura	0,1 mm

M069
€ 610,00
ESTEREOMICROSCOPIO

Caja

Luz propia directa	12 V - 10 W
Distancia de trabajo	165 mm 10x - 119 mm 20x
Alimentación	230 V 50 Hz
Oculares	10x - 20x
Objetivos	1x - 2x
Aumentos	10x \div 40x

E022/5
€ 382,00
SONDA FLEXIBLE

Dimensiones	\varnothing 5,5 mm
Longitud	1070 mm

E022/P
€ 83,20
EXTENSION FLEXIBLE

Dimensiones	\varnothing 18 mm
Longitud	2750 mm

M071
€ 431,00
ESTEREOMICROSCOPIO

Caja

Luz propia incidental y directa	12 V - 10 W
Altura máxima de la pieza a controlar	75 mm
Alimentación	230 V 50 Hz
Oculares	10x
Objetivos	2x - 4x
Aumentos	20x \div 40x

P080
€ 86,40
PINZA AMPERIMÉTRICA DIGITAL

Con pantalla LCD. 7 modos de funcionamiento: corriente alterna, tensión alterna, tensión continua, resistencia, continuidad, frecuencia, control diodo. Gran fiabilidad.



Caja

ACV	4 / 40 / 400 / 600 V ±1,5 % + 4
ACA	4 / 40 / 400 / 600 A ±1,5 % + 4
DCV	4 / 40 / 400 / 600 V ±1,0 % + 2
RES	400 Ω / 4 kΩ / 40 kΩ / 400 kΩ / 4 MΩ / 40 MΩ ±1,0 % + 2
Frecuencia	10 MHz ±0,8 % + 2
Batería	2 x 1,5 V x AA
Dimensiones	250 x 71 x 38,8 mm

P075
€ 145,00
PINZA AMPERIMÉTRICA DIGITAL

Con pantalla LCD. 9 modos de funcionamiento: corriente alterna, tensión alterna, tensión continua, resistencia, continuidad, frecuencia, control diodo, medición de temperatura. Gran fiabilidad.



Caja

ACV	750 V ±1,2 %
ACA	200 - 1000 A ±2,0 %
DCV	1000 V ±1,0 %
DCA	200 - 1000 A ±2,0 %
RES	200 Ω ±1,0 %
Frecuencia	2k Hz ±2,5 %
Temperatura	-40°C - 400°C ±1,5 %
Batería	1 x 9V

0029
€ 6,00
TESTER COMPROBADOR DE CORRIENTE CONTINUA

Para detectar la corriente en los cables de los coches, con los valores de tensión 6-12-24V.



Voltaje	6 - 12 - 24 V
---------	---------------

0013/142
€ 1,80
DESTORNILLADOR BUSCA POLOS

Con mango en material aislante, luz de neón y varilla en acero.



Campo de medición	100 ÷ 500 V
Longitud	142 mm

0013/185
€ 1,96
DESTORNILLADOR BUSCA POLOS

Mango en material aislante, luz de neón y varilla en acero.



Campo de medición	100 ÷ 500 V
Longitud	190 mm

T051
€ 20,60
MULTÍMETRO DIGITAL DE BOLSILLO

Continuidad sonora y control diodos.



Caja

DCV	2-20-200-500V ±0,5%
ACV	200-500V ±1,2%
DCA	200mA ±1,5%
RES	2K-20K-200K-2M Ω ±1%
Batería	1 x A23

T050
€ 40,90
MULTÍMETRO DIGITAL

Con sonda de medición temperatura, continuidad sonora y control diodos.



Caja

DCV	200 mV ±0,5%
DCV	2 V - 20 V - 200 V ±0,8%
DCV	1000 V ±0,1%
ACV	2mV - 20 V - 200 V ±1,0%
ACV	750 V ±1,2%
DCA	2 mA - 20 mA ±1,8%
DCA	200 mA ±2,0%
DCA	20 A ±2,0%
ACA	200 mA ±2,0%
ACA	20 A ±3,0%
RES	200 Ω ±1,0%
RES	2KΩ - 20KΩ - 200KΩ - 2MΩ ±1,0%
RES	20 MΩ ± 1.0%
RES	200 MΩ ±5.0%
Capacidad	2000 pF - 20 nF - 200 nF - 2 μF - 20 μF ±4%
Temperatura	-40 °C ÷ 400 °C ±1,0%
Temperatura	400 °C ÷ 1000 °C ±1,5%
Batería	1x 9V

T053
€ 98,20
MULTÍMETRO DIGITAL

Con sonda de medición temperatura, continuidad sonora y control diodos.



Caja

DCV	200 mV - 2 V - 20 V - 200 V - 1000 V ±0,8%
ACV	200 mV - 2 V - 20 V - 750 V ±1,2%
DCA / ACA	200 μA - 2 mA - 20 mA - 200 mA - 20 A ±2,0%
RES	200Ω - 2kΩ - 20kΩ - 200kΩ - 2MΩ - 20MΩ - 200MΩ ±1%
Capacidad	20 nF / 200 nF / 2 μF / 20 μF / 200 μF / 2000 μF ±2,5%
Inductancia	2 mH - 20mH - 200 mH - 2 H - 20 H
Batería	1x 9V
Temperatura	-20 °C ÷ 1000 °C
Frecuencia	10 mHz
prueba transistor hFE	0 ~ 1000

ML80A
€ 88,90
MEDIDOR DE DISTANCIA LÁSER

Práctico y ligero, ideal para medidas en la construcción y en la carpintería, funciones: adiciones, sustracciones, área y volume, auto apagado.



Blister



Campo de medición	0,05 ÷ 80 m
Precisión	±2 mm
Batería	3 x AAA

ML40
€ 66,10
MEDIDOR DE DISTANCIA LÁSER

Práctico y ligero, ideal para medidas en la construcción y en la carpintería, funciones: adiciones, sustracciones, área y volume, auto apagado.



Blister



Campo de medición	0,05 ÷ 40 m
Precisión	± 2 mm
Batería	2 x AAA

T068
€ 144,00
MEDIDOR DE TEMPERATURA INFRARROJO CON INDICADOR LÁSER

No es adecuado para medir la temperatura corporal.



Caja

Campo de medición	-30°C÷550 °C -22 F÷1022 F
Precisión	-30 °C ÷ 0 °C -22 F ÷ 32 F ±3 % o ±3 °C
Precisión	0 °C ÷ 100 °C 32 F ÷ 212 F ±2 % o ±2 °C
Precisión	> 100 °C > 212 F ±3 % o ±3 °C
Lectura	0,1 °C 0,1 F
Emisión	0,1 ÷ 1,0
Batería	1x 9V
Dimensiones	146 x 80 x 38 mm
Distancia/Diámetro del área	1 : 12

T064
€ 111,00
MEDIDOR DE TEMPERATURA INFRARROJO CON INDICADOR LASER

No es adecuado para medir la temperatura corporal.



Blister

Campo de medición	-25°C÷400 °C -13 F÷752 F
Precisión	-25 °C ÷ 400 °C ±(2 % + 1 °C)
Precisión	-13 F ÷ 752 F ±(2 % + 1 F)
Lectura	1 °C 2 F
Batería	1x 9V
Distancia/Diámetro del área	1 : 10
Tiempo de medición	0.5 s
Emisión Preestablecido	0.95

T057
€ 246,00
MEDIDOR DIGITAL DE TEMPERATURA Y HUMEDAD DE AMBIENTE

Gran precisión, con microordenador LSI



Estuche de transporte

Temperatura	-10 °C ÷ +65 °C
Lectura temperatura	0,1 °C
Precisión temperatura	±0,5 °C
Humedad	10 % ÷ 100 %
Precisión	2 % ±1 % RH
Batería	4 x 1,5 V AA
Tiempo de respuesta	0.4 s
Consumo de energía	16 mA
Dimensiones	202 x 72 x 37 mm

I002
€ 359,00
HIGROMETRO PARA MEDIR LA HUMEDAD

De madera y materiales de construcción, no apto para medir la humedad ambiental.



Estuche de transporte

Temperatura de funcionamiento	0 °C - 40 °C
Campo de medición	0 - 80 %
Materiales de fabricación	0 - 50 %
Lectura	0,1 %
Precisión	± (0,5 % n+1)
Batería	4 x 1,5 V AA
Dimensiones	165 x 62 x 26 mm

T054
€ 40,90
MEDIDOR DIGITAL DE TEMPERATURA DE BOLSILLO

Con sonda para medir temperatura ambiente o por inmersión.



Caja

Lectura	1 °C
Campo de medición	-50°C ÷ 1100°C con el uso de la sonda T056/TP03 no suministrada, -50°C ÷ 750°C con el uso de la sonda T056/TP02 suministrada
Precisión	0°C ÷ 500°C ±(0,75% + 1°C), 500°C ÷ 750°C ± (1% + 1°C), 750°C ÷ 1000°C ± (2% + 1°C), 1000°C ÷ 1200°C ± (4% + 3°C)
Sonda tipo	"K"
Batería	1x 9V

T063
€ 74,00
MEDIDOR DIGITAL DE TEMPERATURA PORTATIL

Con funda.



Caja

Campo de medición	T056/TP01: -50°C ÷ 250°C
Campo de medición	T056/TP02: -50°C ÷ 750°C
Lectura	1 °C
Precisión	-50 °C ÷ 1200 °C ±(0.3 % + 2 °C)
Precisión	1200°C ÷ 1300 °C ±(0.6 % + 2 °C)
Precisión	-58 F ~ 1200 F ±(0.3 % + 2 F)
Precisión	1200 F ~ 1999 F ±(0.6 % + 2 F)
Batería	1x 9V

T055
€ 159,00
MEDIDOR PORTATIL DIGITAL DE TEMPERATURA

Con funda de plástico.



Caja

Campo de medición	T056/TP01: -50°C ÷ 250°C
Campo de medición	T056/TP02: -50°C ÷ 750°C
Lectura	0,1 F
Lectura	0,1 °C
Precisión	±(0,3% n+1.8 F)
Precisión	±(0,3% n+1 °C)
Dimensiones	178 x 68 x 39 mm
Longitud total de sonda	120 mm
Batería	4 x 1,5 VAA

F010
€ 338,00
FONOMETRO DIGITAL

Gran precisión, modo de medición Fast, Slow, Max. Conexión con ordenador para transferencia de datos.



Estuche de transporte

Respuesta de frecuencias	31,5 Hz ÷ 8 kHz
Campo de medición	30 dB ÷ 130 dB (A) 32 dB ÷ 130 dB (C) 35 dB ÷ 130 dB (Lineare)
Lectura	0,1 dB
Funciones	SL, LN, Leq (nivel equivalente)
Características de detección	Fast, Slow, Max
Tiempo de medición	0,1 s
Pantalla	10 mm
Temperatura de funcionamiento	-10 °C ÷ 40 °C
Baterías no incluidas	4 x 1,5 V AAA
Tiempo de respuesta	1 s
Dimensiones	236 x 63 x 26 mm

T056/TP01
€ 9,70
SONDA DE TIPO "K" PARA LA TEMPERATURA AMBIENTE

Campo de medición	-50°C ÷ 250°C
Tipo de sonda	"K"
Longitud sonda	2 mm

T056/TP02
€ 11,90
SONDA DE TIPO "K" PARA LA TEMPERATURA AMBIENTE O LA INMERSIÓN

Campo de medición	-50°C ÷ 750°C
Tipo de sonda	"K"
Longitud total	135 mm

T056/TP03
€ 70,70
SONDA TIPO "K"

Para la temperatura ambiente o la inmersión.



Campo de medición	-50 °C ÷ 1100 °C
Tipo de sonda	"K"
Longitud sonda	650 mm

A005
€ 226,00
ANEMOMETRO DIGITAL

Estuche de transporte

MEDICIÓN VELOCIDAD DEL AIRE

Unidad de medida	m/s - Km/h - ft/min - Knots
Gama velocidad mandril	0,4 ÷ 30,0 / 1,4 ÷ 108 / 80 ÷ 5910 / 0,8 ÷ 58,3
Lectura	0,1
Precisión	± (2%+1 cifra) / ± (2%+3 cifre) / ± (2%+2 cifre) / ± (2%+2 cifre)
MEDICIÓN TEMPERATURA	
Campo de medición	0°C÷60°C 32 F÷140 F
Lectura	0,1° C 0,1 F
Precisión	0,5°C 0.9 F
Batería	1x 9V no incluida

L014
€ 79,00
LUXMETRO DIGITAL

Estuche de transporte

Campo de medición	0 LUX ÷ 2000 LUX ÷ 20000 LUX ÷ 50000 LUX
Resolución	1 LUX
Precisión	± 5 %
Batería	1x 9V

MD01
€ 129,00
DETECTOR DE METALES

Análogo, con 2 Led de color que muestran el tipo de metal que se detecta, sensor de audio, volumen ajustable, sintonización automática, disco simple, bobina de búsqueda impermeable, soporte de brazo cómodo e indicador de batería baja.



Caja

Diametro de la bobina	170 mm
Conector jack	1/4"
Sensibilidad	> 15 cm per una moneda di Ø 25 mm
Batería	1x 9V

C069
€ 121,00
CUENTA VUELTAS DIGITAL A CONTACTO

Estuche de transporte

Velocidad de rotación	2,5 - 9999,9 rpm
Velocidad tangencial	0,05 - 999,99 m/min
Lectura	0,1 (7,5 - 999,9) rpm
Lectura	1 (1000-9999,9) rpm
Precisión	± 0,05 % + 1 cifra
Dimensiones	190 x 72 x 37 mm
Batería	4 x 1,5 V AA

O387A
€ 74,00
DETECTOR DIGITAL

Para medir metales ferrosos y no ferrosos, madera y cables vivos en paredes, techos y pisos.



Caja

Máxima profundidad de detección	
Metales ferrosos	100 ± 5 mm
Metales no ferrosos	70 ± 5 mm
Madera	20 ± 5 mm
Cables en tensión	50 ± 5 mm
Batería	1x 9V
Dimensiones	150 x 75 x 24 mm

C070
€ 169,00
CUENTA VUELTAS DIGITAL A CONTACTO Y ÓPTICO

Con tiras reflectantes.



Estuche de transporte

Velocidad de rotación óptica	2,5 ÷ 9999,9 rpm
Velocidad de rotación contacto	0,05 ÷ 999,9 rpm
Velocidad tangencial	0,1 ÷ 999,99 m / min
Lectura	0,1 (2,5 ÷ 999,9) rpm
Lectura	1 (1000 ÷ 9999,9) rpm
Distancia de uso	da 50 ÷ 60 mm a 50 ÷ 250 mm (con ottico)
Precisión	± 0,05 % + 1 cifra
Dimensiones	220 x 75 x 29 mm
Batería	4 x 1,5V AA
Temperatura de funcionamiento	0°C ÷ 40°C
Tiempo de medición	0.8 s

C067
€ 121,00
CUENTA VUELTAS ÓPTICO DIGITAL

Con tiras reflectantes.



Estuche de transporte

Campo de medición	2,5 ÷ 9999,9 rpm
Lectura	0,1 (2,5 ÷ 999,9) rpm
Lectura	1 (1000 ÷ 9999,9) rpm
Distancia de uso	da 50 ÷ 60 mm a 50 ÷ 250 mm
Precisión	± 0.05% de lectura + 1 dígito
Dimensiones	170 x 72 x 37 mm
Batería	4 x 1,5V AA

0543 € 22,80

MEDIDOR DE PRESIÓN DIGITAL EMERGENCIA COCHE

Adecuado en condiciones de emergencia, se puede utilizar en 4 maneras diferentes: medidor de presión digital, linterna eléctrica de Led, martillo de emergencia, cortador de cinturón de seguridad.



Blister



Campo de medición	3÷150 psi 0,21÷10,34 bar 21÷1034 kPa
Temperatura de funcionamiento	-20°C ~ +50° C
Batería	2x 1.5V AA

V002 € 1190,00

MEDIDOR DE VIBRACIONES

Con sonda magnética, 2 puntas, software y cable usb.

Aceleración	0,1 ÷ 400 m/s ²
Velocidad	0,01 ÷ 40 cm/s
Desplazamiento	0,001 ÷ 4 mm
Equilibrado rpm	60 ÷ 99,990
Frecuencia	1÷20 kHz
Precisión	± 5 %
Batería	4 x 1,5 V AA

0836 € 19,00

MEDIDOR DE PRESION DIGITAL

Con luz de Led.



Blister



Campo de medición	0,5÷99,5 psi 0,034÷6,86 bar, 3,45÷686 kPa
Precisión	±1%
Batería	3 x SR44

S004 € 1630,00

MEDIDOR DE ESPESORES A ULTRASONIDOS

Resolución	4-digit LCD
Campo de medición	1,0 ÷ 225,0 mm
Precisión	±0,1 mm
Dimensiones	126 x 68 x 23 mm
Batería	2 x 1,5 V AA

0583 € 98,20

REFRACTOMETRO BRIX

Estuche de transporte

Campo de medición	0 ÷ 80 % Brix
-------------------	---------------

0433 € 90,10

REFRACTÓMETRO

Brix para aceites solubles.



Estuche de transporte

Campo de medición	0 ÷ 32% Brix
-------------------	--------------

0312 € 98,20

REFRACTOMETRO PARA LIQUIDOS DE COCHE

Estuche de transporte

Escala para líquidos anticongelantes E	-50 °C ÷ 0 °C
Escala para líquidos anticongelantes P	-50 °C ÷ 0 °C
Escala para líquidos batería B	1,10 ÷ 1,40 SG
Escala para líquidos limpiaparabrisas C	-40 ÷ 0°C

0312/AB € 73,60

REFRACTÓMETRO PARA LÍQUIDOS DE COCHE + ADBLUE

Estuche de transporte

Escala para líquidos anticongelantes E	-40 °C ÷ 0 °C
Escala para líquidos anticongelantes P	-50 °C ÷ 0 °C
Escala para líquidos batería B	1,10 ÷ 1,40 SG
AdBlue	30 ÷ 35 %

D001
€ 2670,00
DURÓMETRO DE BANCO

Caja de madera

Lectura	0,5 HR
Penetrador de diamante y de bola	n° 1+1
Yunques planos	n° 2
Yunque en V	n° 1
Bloques de calibrado	n° 5 (HRC, 3xHRB, HRA)
Altura máxima de la pieza a medir	170 mm
Profundidad de medición	125 mm
Dimensiones durómetro	185 x 465 x 640 mm
Fuerza de medición	588,4 N / 980,7 / 1471 N (60 kgf / 100 kgf / 150 kgf)
ESCALAS DE MEDICIÓN:	
HRC	20 ÷ 70
HRB	25 ÷ 100
HRA	20 ÷ 88
Peso neto	90 kg

D018
€ 5110,00
DURÓMETRO DE BANCO

Motorizado, rockwell, brinell y vickers.



Caja de madera

Fuerza de medición	294,2 N / 306,5 N / 588,4 N / 612,9 N / 980,7 N / 1471 N / 1839 N; 30 kgf / 31,25 kgf / 60 kgf / 62,5 kgf / 100 kgf / 150 kgf / 187,5 kgf
Penetrador de diamante con cono y pirámide	n° 1+1
Penetrador de bola	n° 3
Yunques planos	n° 2
Yunque en V	n° 1
Bloques de calibrado	n° 2 Brinell; n° 2 Rockwell; n° 1 Vickers
Aumentos	37,5x - 75x
Altura máxima de la pieza a medir	Rockwell: 175 mm; Brinell - Vickers: 145 mm

Profundidad de medición	160 mm
Alimentación	230 V - 50 / 60 Hz - 6 W
Dimensiones durómetro	525 x 240 x 730h mm
ESCALAS DE MEDICIÓN:	
HBS	4 - 450
HRB	20 - 100
HRA	20 - 88
HRC	20 - 70
HV	200 - 1000
Peso neto	70 kg



D007/A
€ 86,10
DUROMETRO SHORE "A"

Medidor de dureza para goma blanda, piel, fieltros, cera.



Campo de medición	0 ÷ 100 A
Lectura	2 A

D011/A
€ 150,00
DUROMETRO SHORE "A" DIGITAL

Medidor de dureza para goma blanda, piel, fieltros, cera.



Campo de medición	0 ÷ 100 A
Lectura	0.5 A
Batería	1 x 3 V CR2032

D011/D
€ 150,00
DUROMETRO SHORE "D" DIGITAL

Medidor de dureza para goma dura y plasticos..



Campo de medición	0 ÷ 100 D
Lectura	0.5 D
Batería	1 x 3 V CR2032

P013
€ 157,00
BLOQUES DE PRUEBA DUREZA EN GOMA SHORE "A"

Con dureza variable da 26ha a 88ha, bloques de color purple, marrón, verde, naranja, rojo, amarillo y gris. Precisión ±2ha.



7 Pcs

S110
€ 431,00
DUROMETRO

Para medir la dureza del cemento.



Energía de percusión	2.207 Nm
Tensión resorte	7.84 N
Recorrido	75 mm

S111
€ 476,00
YUQUE PARA CALIBRACION DUROMETRO

B031
€ 25,40
BALANZA DE PRECISIÓN DIGITAL Y PORTATIL

No legal para el comercio.



Caja

Capacidad	100 g
Lectura	0,01 g
Tipo de pesaje	g / dwt / tl / ct
Batería	1 x 3 V CR2032

B021
€ 20,60
BALANZA DE PRECISIÓN DIGITAL Y PORTATIL

No legal para el comercio.



Caja

Capacidad	500 g
Lectura	0,1 g
Tipo de pesaje	g / dwt / gn / ct
Batería	2 x 1,5V AAA

B003/5/1
€ 36,90
BALANZA ELECTRÓNICA DIGITAL

No legal para el comercio, funcion tara, autoapagado.



Caja

Capacidad	5 kg - 176,4 oz
Lectura	1 g 0,1 oz
Batería	2 x 1,5V AA
Dimensiones	170 x 240 x 35 mm

B018
€ 134,00
BALANZA ELECTRÓNICA DIGITAL DE DOBLE PANTALLA

No legal para el comercio



Caja

Capacidad	30 g
Lectura	10 g
Dimensión plato	340 x 230 mm
Dimensiones	350 x 330 x 120 mm
Alimentación	230V 50 Hz
Batería recargable	1 x 4 V 4 Ah

B004-
BALANZAS ELECTRÓNICAS DIGITALES CUENTAPIEZAS Y BATERÍAS RECARGABLES

No legal para el comercio.

0561/B
€ 38,50
BATERIA RECAMBIO

Para todas las balanzas b004.



Caja

Art.	€	Capacidad	Lectura	Dimensiones balanza de banco	Dimensiones plato	Batería recargable
B004/7	€ 410,00	7,5 kg	0,2 g	350 x 340 x 105 mm	335 x 228 mm	1 x 6 V 4 Ah
B004/30	€ 410,00	30 kg	1 g	350 x 340 x 105 mm	335 x 228 mm	1 x 6 V 4 Ah



B004/150

€ 800,00

BALANZA ELECTRÓNICA DIGITAL CUENTAPIEZAS Y BATERÍAS RECARGABLES

No apto para transacciones comerciales, equipado con batería de 6V 4A y cargador.

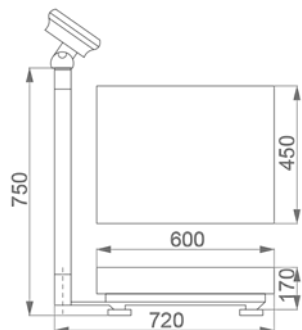

Caja

Capacidad	150 kg
Lectura	10 g
Batería recargable	1 x 6 V 4 Ah
Peso neto	17 kg

0561/B

€ 38,50

BATERIA RECAMBIO

Para todas las balanzas b004.



D010-

DINAMÓMETROS DIGITALES

Con estructura de fundición de aluminio, equipada con batería, cargador, mando a distancia por infrarrojos y señal acústica Doble unidad de medida kg / lb. Con funciones de pico, retención, tara, cero y suma. Fuentes grandes para facilitar la lectura. No apto para relaciones con terceros.



Caja

Art.	€	Tamaño caracteres	Capacidad	Lectura	Pesaje mínimo	Carga límite	Batería	Peso neto
D010/0100	€ 622,00	40 x 20 mm	1000 kg	0.500 kg	0.500 kg	150%	1 x 6 V 4 Ah	7,1 kg
D010/0300	€ 749,00	40 x 20 mm	3000 kg	1 kg	1 kg	150%	1 x 6 V 4 Ah	7,5 kg
D010/0500	€ 876,00	40 x 20 mm	5000 kg	2 kg	2 kg	150%	1 x 6 V 4 Ah	12,3 kg
D010/1000	€ 1100,00	40 x 20 mm	10000 kg	5 kg	5 kg	150%	1 x 6 V 4 Ah	25,7 kg

D012-

DINAMÓMETROS DIGITALES

Equipado con batería, cargador, control remoto, retroiluminación y señal sonora. Unidad de medida doble kg/lb. Con funciones Peak, Hold, Tare y Zero. Fuentes grandes para facilitar la lectura. No apto para relaciones con terceros.



Caja

Art.	€	Tamaño caracteres	Capacidad	Lectura	Pesaje mínimo	Carga límite	Batería recargable	Peso neto
D012/0100	€ 938,00	40 x 20 mm	1001 kg	0,200 kg	0,200 kg	150%	1 x 6 V 10 Ah	12 kg
D012/0300	€ 1110,00	40 x 20 mm	3001 kg	0,500 kg	0,500 kg	150%	1 x 6 V 10 Ah	14,5 kg
D012/0500	€ 1280,00	40 x 20 mm	5001 kg	1 kg	1 kg	150%	1 x 6 V 10 Ah	19 kg
D012/1000	€ 1530,00	40 x 20 mm	10001 kg	2 kg	2 kg	150%	1 x 6 V 10 Ah	32 kg